

Wiegand-to-RS232 Converter (MA1405)

MaCaPS MA1405 is a Wiegand-to-RS232 Bidirectional converter. The converter can automatically convert Wiegand input from 3-bit up to 42-bit to a formatted ASCII string. When the formatted ASCII string is used as input to the RS232 port of another MA1405 unit, the formatted ASCII string is reconverted to Wiegand format output.



1 Specification:

1.1 Communications:

9600 BPS ASYNC, 8 bits, 1 Stop, No Parity.

1.2 Wiegand Input/Output Format

The format of the Wiegand bit stream is shown as follows:

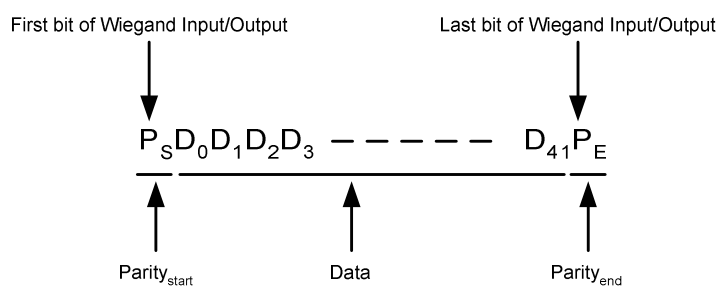

1.3 RS232 Input/Output Format

The format of the RS232 is in the form of 16-byte ASCII string (In Hex format) as follow:

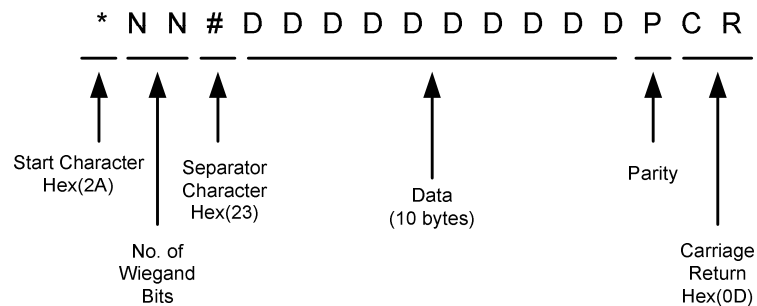

The **Parity Character P** is decoded as follows:

RS232 Side	Wiegand Side	
P	P _S	P _E
0	0	0
1	0	1
2	1	0
3	1	1

1.4 Command Data:

4 Bytes Hex Value	Description
02 _H 31 _H 30 _H 03 _H	Turn on Reader Green LED
02 _H 31 _H 31 _H 03 _H	Turn off Reader Green LED
02 _H 31 _H 32 _H 03 _H	Toggle LED (Bi-Color LED Turns Orange)
02 _H 32 _H 30 _H 03 _H	Turn on Reader Buzzer
02 _H 32 _H 31 _H 03 _H	Turn off Reader Buzzer
02 _H 33 _H 30 _H 03 _H	Turn on Converter LED
02 _H 33 _H 31 _H 03 _H	Turn off Converter LED
02 _H 34 _H 30 _H 03 _H	Turn on Converter Relay
02 _H 34 _H 31 _H 03 _H	Turn off Converter Relay
02 _H 35 _H 30 _H 03 _H	Turn on Converter Buzzer
02 _H 35 _H 31 _H 03 _H	Turn off Converter Buzzer
02 _H 36 _H 30 _H 03 _H	Turn on Reader Red LED
02 _H 36 _H 31 _H 03 _H	Turn off Reader Red LED

2 Pin Connectors:

The schematic of the MA1405 is shown in the following figure.

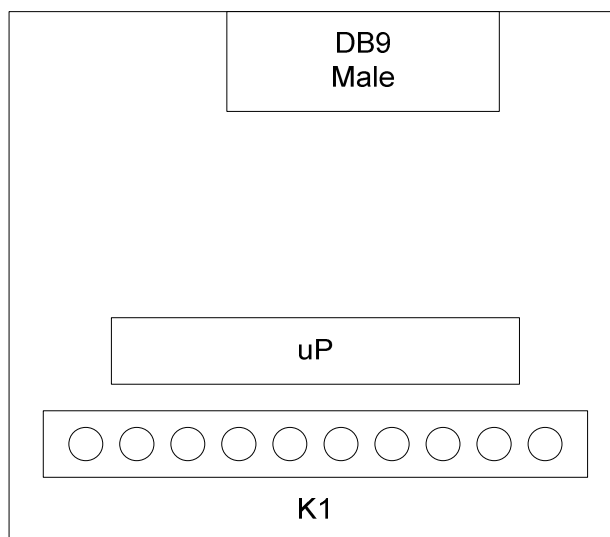

2.1 Connector K1

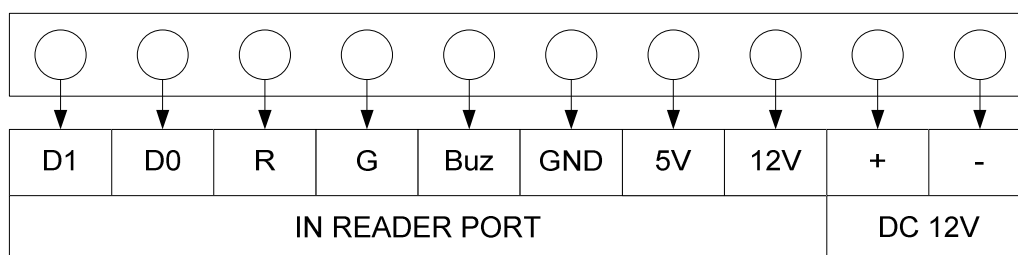

- D1: Wiegand Data 1
- D0: Wiegand Data 0
- R: To Reader Red LED
- G: To Reader Green LED
- Buz: To Reader Buzzer
- GND: Ground
- 5V: 5V DC output
- 12V: 12V DC output
- +: Power Supply +12V In
- : Power Supply Ground

2.2 DB 9 Male

1. DCD Unused
2. TX data from converter
3. RX data from terminal
4. DTR Unused
5. Ground
6. DSR Unused
7. RTS Unused
8. CTS Unused

3 Example

3.1 Wiegand-to-RS232

Input: Wiegand (26-bit)

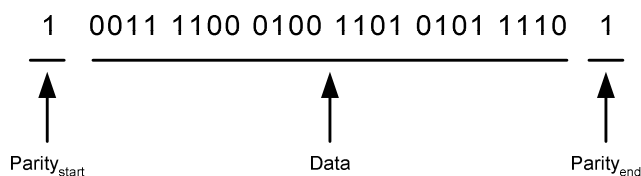

Output: 16-byte ASCII string from RS232 port

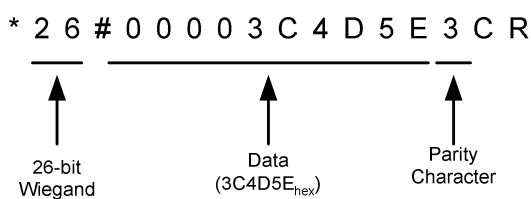

3.2 RS232-to-Wiegand

This is a reversed process of Wiegand-to-RS232

Input: 16-byte ASCII string to RS232 port

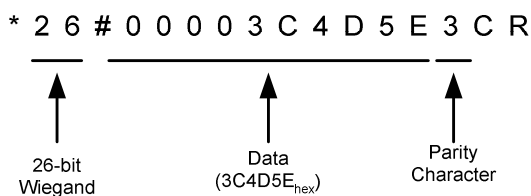

Output: Wiegand (26-bit)

